

JVC

LT-32DS6BJ LT-26DS6BJ
LT-32DS6SJ LT-26DS6SJ

WIDE LCD PANEL TV INSTRUCTIONS

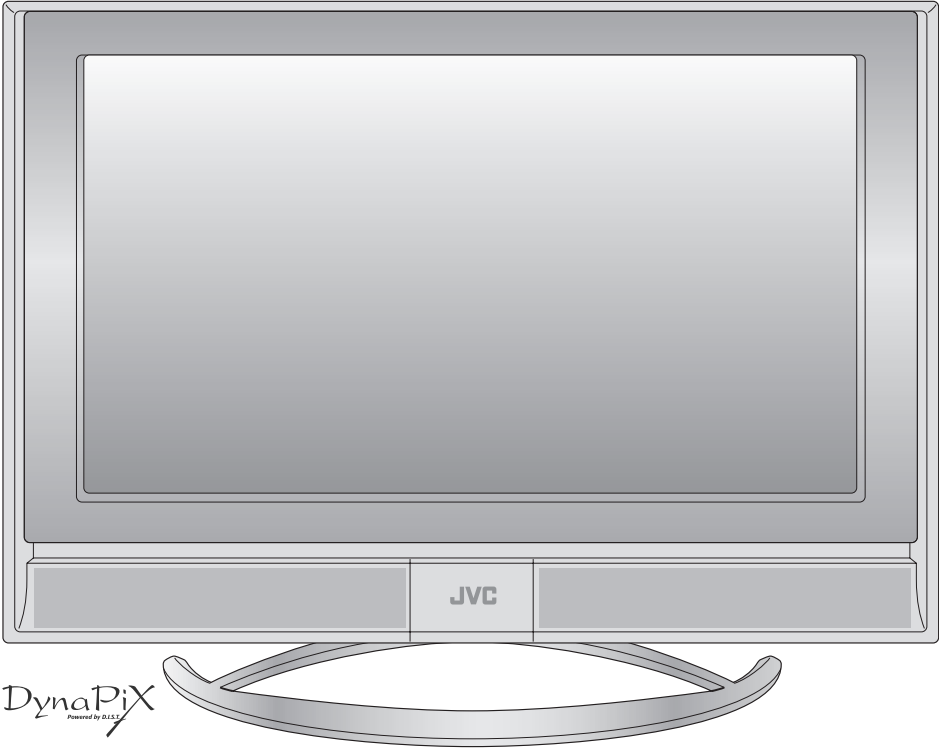

DynaPiX
Powered by D.L.I.

InteriArt
HDMI™
HIGH-DEFINITION MULTIMEDIA INTERFACE

T-V LINK

DVB®
**Digital Video
Broadcasting**

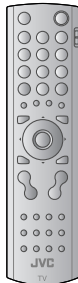

Trade Mark of the DVB Digital Video Broadcasting
Project (1991 to 1996) Number : 3476, 3477, 3478, 3479

LCT1847-001A-U

Expanding the world of



beautiful images

Enjoy rich multi-media with JVC

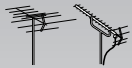

VHF / UHF / DVB-T broadcasting

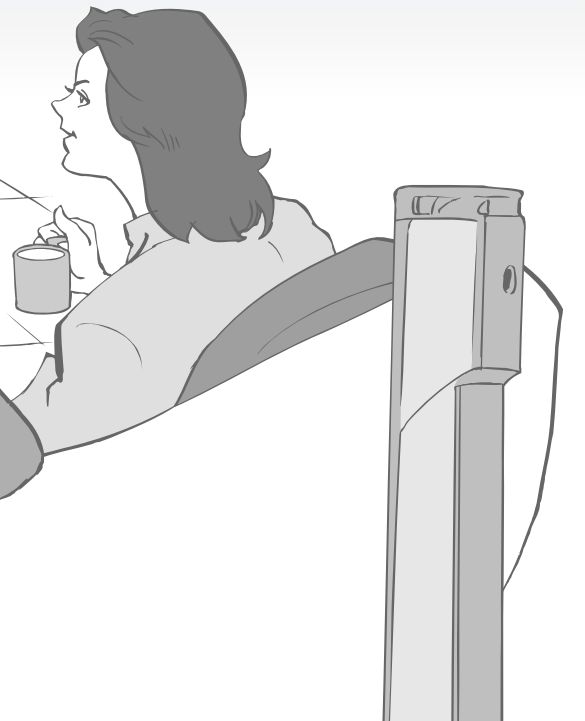
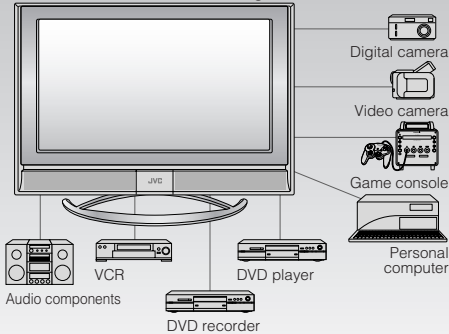

Contents

*In this manual,
ATV : analogue terrestrial broadcasting (VHF/UHF)
DTV : digital terrestrial broadcasting (DVB-T)

First things first!

- Warning 4

Getting started

- Names of all the parts 6
- Basic connections 8
- Connecting external devices 10
- Initial settings 12
- Editing DTV channels 14
- Editing ATV channels 16

Let's try it out

- Enjoying your new TV! 18
 - TV / Teletext / EPG / Video / Menu
- Watching TV 20
- Using EPG 22
- Viewing teletext 24
- Watching videos / DVDs 26

Try the advanced features

- Useful functions 28
 - Multi-picture / Favourite channel
 - Sleep timer / Child lock

Just the way you like it

- Customising your TV 32
- Using DTV 34
- Advanced picture adjustment 40
 - Reduce noise / Watch a more natural picture
 - Set the aspect ratio, etc.

When you have trouble

- Troubleshooting 42
- CH/CC List 45
- Technical information 46
- Specifications 47

IMPORTANT!

PREPARE

USE

SETTINGS

TROUBLE?

Warning

Please follow all the guidelines below

Never cut or damage the power cord!

- If the AC plug is not the right shape, or the power cord is not long enough, use an appropriate plug adapter or extension cable.
(Consult your retailer.)

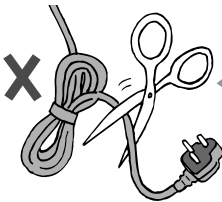

Never try to repair the TV yourself!

➔ If the problem cannot be solved in "Troubleshooting" (P. 42), unplug the power cord and contact your retailer.

- If you have cut or damaged the power cord.
➔ "Technical information" (P. 46)
- To change the fuse in UK plugs
➔ "Technical information" (P. 46)

Never place anything on the TV!

- Placing liquids, naked flames, cloths, paper, etc. on the TV may cause a fire.



Follow this manual regarding setup!

- Connect only to a 110-240V, 50/60Hz AC outlet.

Unplug the power cord when going out!

- The power buttons on the remote control and the TV unit can not completely turn off the TV. (Make appropriate arrangements for bedridden people.)

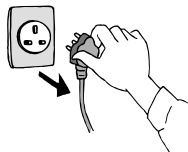

Never insert objects into the cabinet openings!

- It may cause a fatal electric shock. Take care when children are near.



■ For more details on installation, usage and safety ➔ Consult your retailer

Never expose to rain or moisture!

- To prevent fire or electric shock, never allow liquids to enter the unit.



Do not allow the TV to fall!

- Do not rest your elbows on, or allow children to hang from the TV. There is a risk that the TV will fall and cause injuries.

Hold the TV so as not to scratch the screen!

- Do not touch the screen when carrying the TV.

Do not carry the TV on your own!

- In order to prevent accidents, ensure that the TV is carried by two or more people.



If the TV is damaged or behaving strangely, stop using it at once!

- ➔ Unplug the power cord and contact your retailer.

When attaching the TV to the wall, use the optional JVC wall mounting unit!

- Consult a qualified technician.
- See the included manual on mounting procedures.
- JVC assumes no responsibility for damage due to improper mounting.

Never dismantle the rear panel!

- It may cause an electric shock.

Never obstruct the ventilation holes!

- It may cause overheating or a fire.

Handle LCD panel with care!

- Use a soft, dry cloth when cleaning.

Never listen to headphones at high volume!

- It may damage your hearing.

Names of all the parts

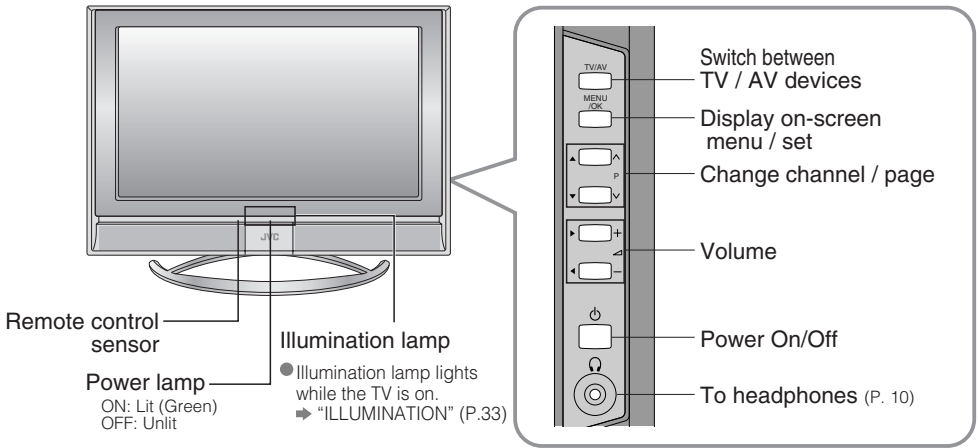

Remove the terminal covers

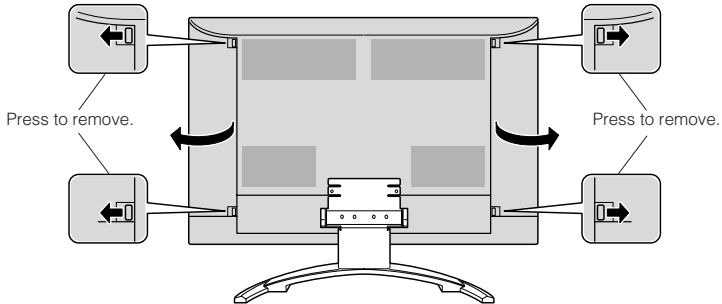

- If the cover cannot be closed due to the cables being in the way
➔ Do not force the cover to close (leave it open).
- Connecting terminals on the back of the TV ➔ Connecting External devices (P. 10)

Change the direction of TV

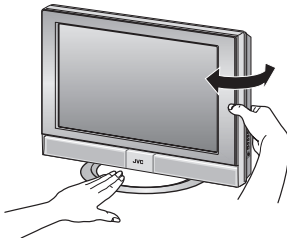

Check accessories



Remote control
(RM-C1813H)



AA/R6 Batteries
(For confirming the TV works)

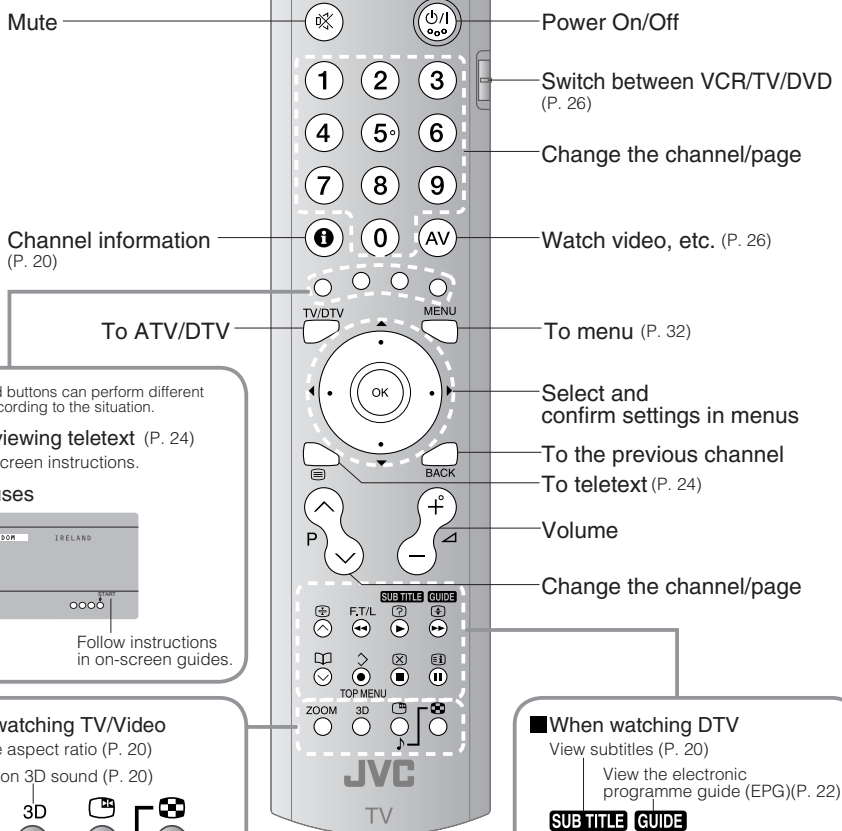

The coloured buttons can perform different functions according to the situation.

■ **When viewing teletext (P. 24)**
Follow on-screen instructions.

■ **Other uses**

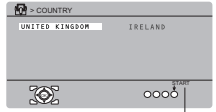

Follow instructions in on-screen guides.

■ **When watching TV/Video**
Change the aspect ratio (P. 20)

Turn on 3D sound (P. 20)

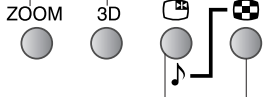

Take a snapshot of the screen (P. 20)

View in multi-picture mode (P. 28)

■ **Insert the batteries**

Use two AA/R6 dry cell batteries. Insert the batteries from the - end, making sure the ⊕ and ⊖ polarities are correct.

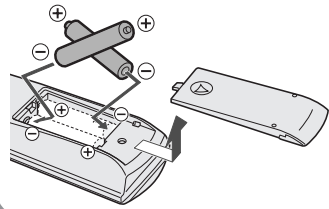

■ **When watching DTV**
View subtitles (P. 20)

View the electronic programme guide (EPG)(P. 22)

SUB TITLE GUIDE



■ **When watching ATV (P. 16)**
when viewing teletext (P. 24)

SUB TITLE GUIDE

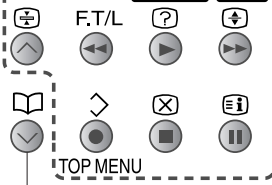

■ **When choosing a favourite channel (P. 29)**

■ **When operating a JVC VCR or DVD (P. 26)**

Basic connections

Please read the user manuals of each device carefully before setup.
It is necessary to connect an aerial to watch TV.

■ **Connect with other devices** → "Connecting external devices" (P. 10)

Connect the aerial

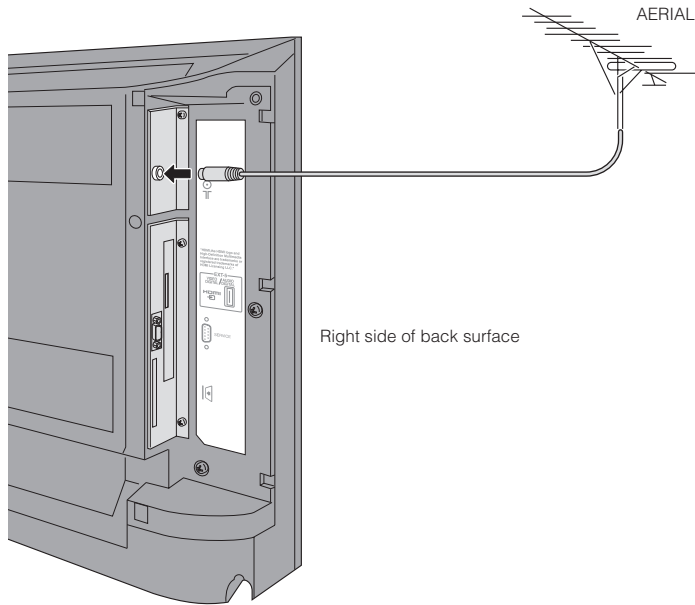

- After all the connections have been made, insert the plug into an AC outlet.

Care when setting

■ Power requirements

- Connect the power cord only to a 110-240V, 50/60Hz AC outlet.

■ When attaching the TV to the wall, use the optional JVC wall mounting unit

- Consult a qualified technician.
- See the included manual on mounting procedures.
- JVC assumes no responsibility for damage due to improper mounting.

■ Installation requirements

- To avoid overheating, ensure the unit has ample room.

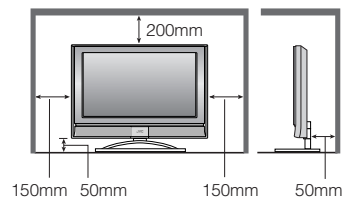

Connect a VCR / DVD recorder

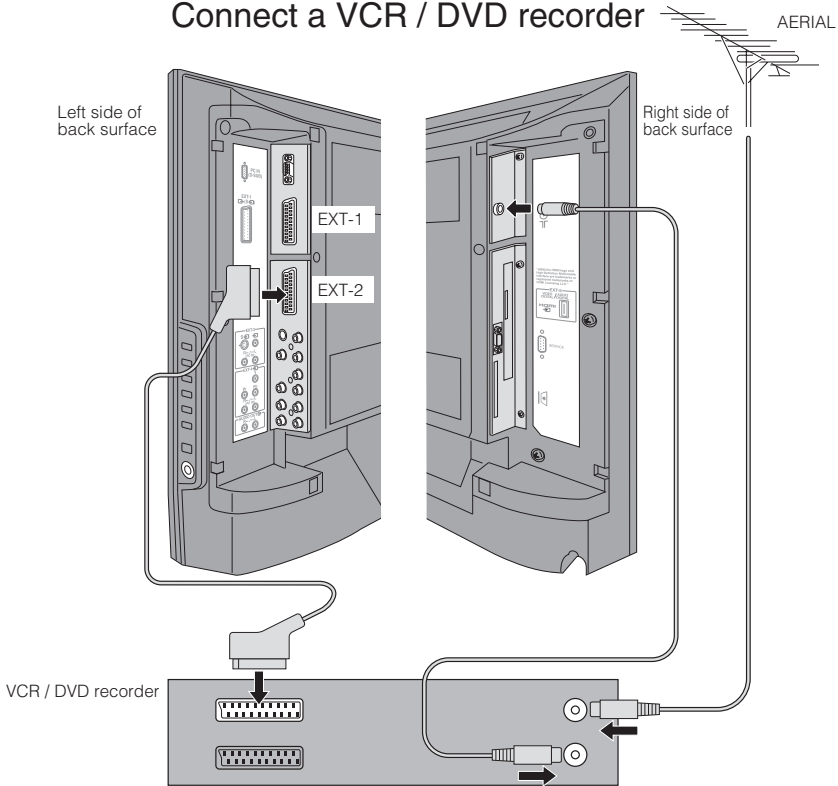

- After all the connections have been made, insert the plug into an AC outlet.
- Connect T-V LINK compatible recording device to EXT-2.
- T-V LINK → "What is T-V LINK?" (P. 12)

Watch pay-per-view

Contract with a broadcasting company beforehand.

- ① Unplug the power cord
 - ② Insert the Viewing Card into the CAM.
 - ③ Insert the CAM.
 - ④ Plug the power cord, and turn the power on.
 - Set pay-per-view → (P. 38)
- The CAM and Viewing Card will be sent by the broadcasting company after contracting with them.

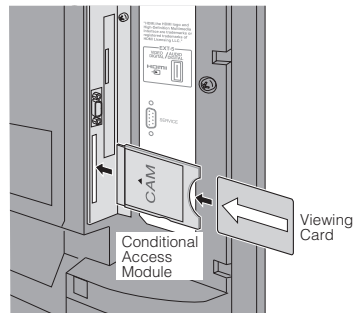

Connecting external devices

You can connect many different devices to the rear panel of the TV.
Please read the user manuals of each device before setting up.
(Connecting cables are not supplied with this TV.)

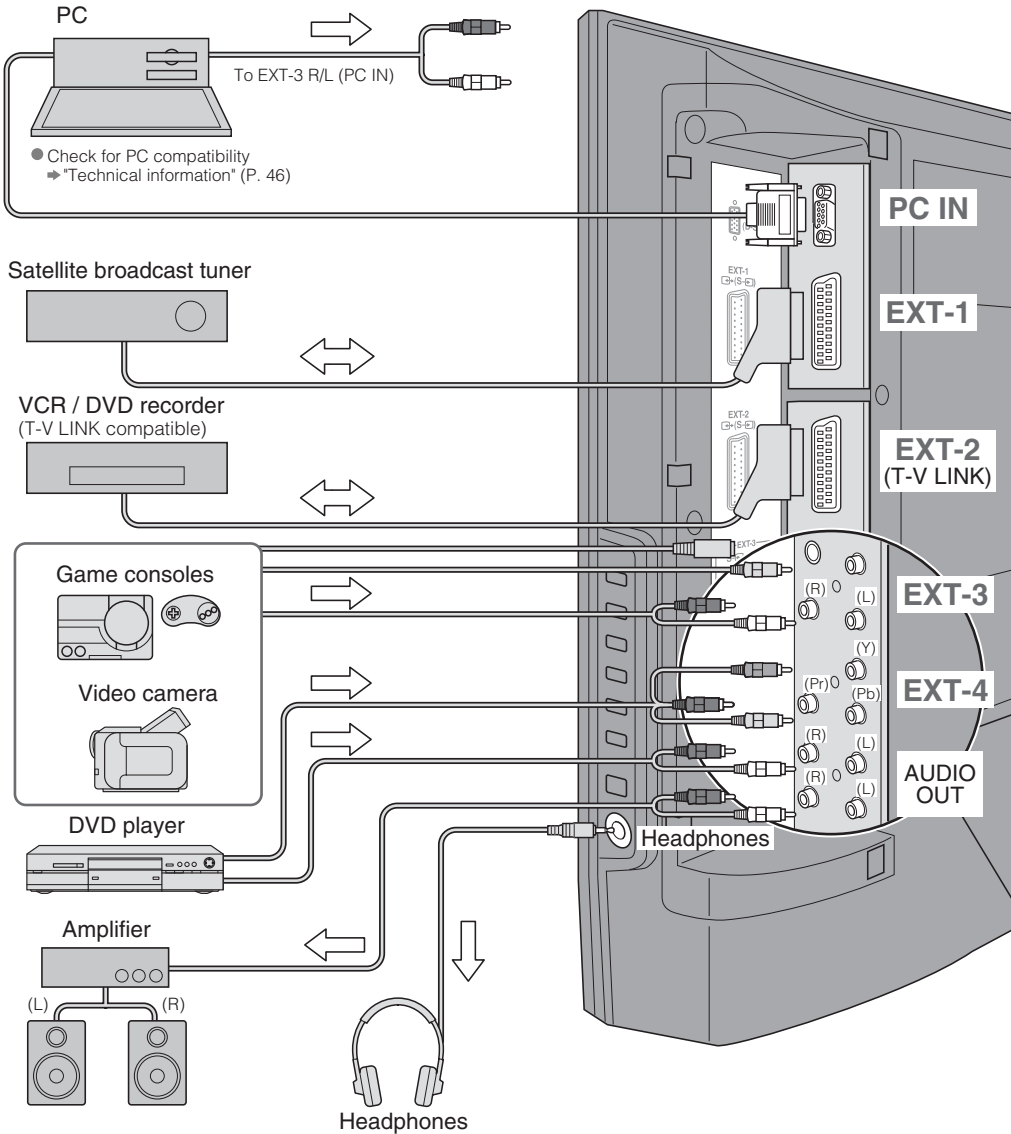

VCR / DVD / other devices

→ : signal direction

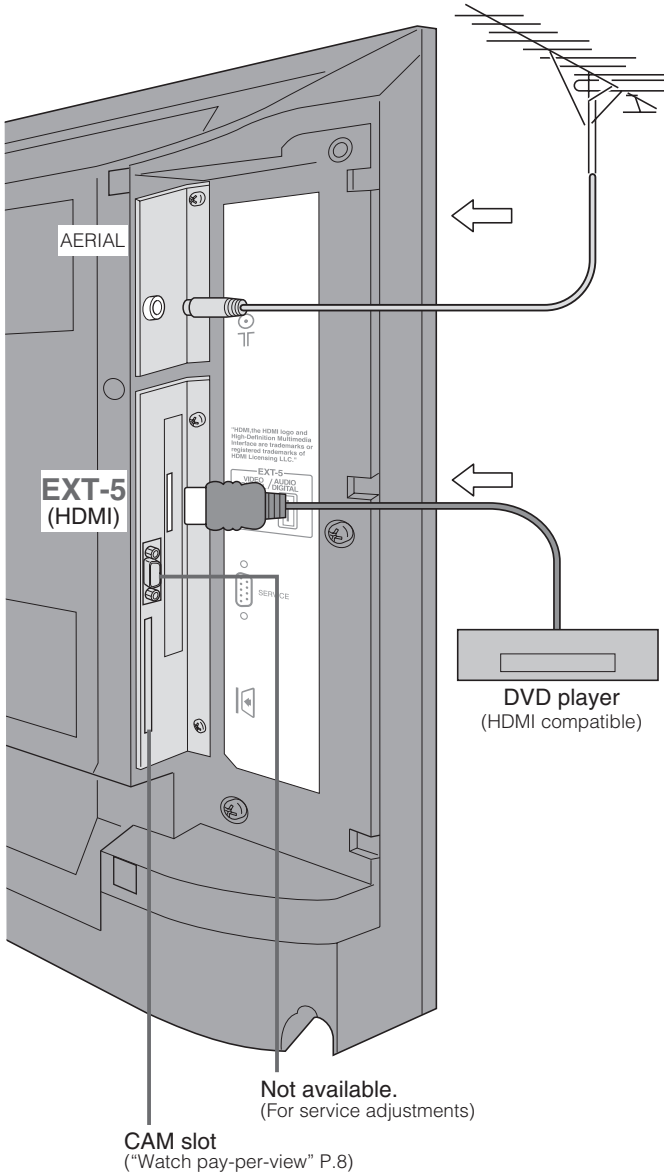

■ **Connect DVI devices**
→ (P. 46)

■ **T-V LINK** → (P. 12)

EXT-1 Watching videos

Output ↑	Input ↓
· Composite signal	· Composite signal /
· Sound L / R	· RGB / S-VIDEO
	· Sound L / R

● Use S-VIDEO → "S-IN" (P. 27)

EXT-2 Dubbing videos Using T-V LINK

Output ↑	Input ↓
· Composite signal	· Composite signal /
· S-VIDEO (only for DTV)	· RGB / S-VIDEO
· Sound L / R	· Sound L / R
	· T-V LINK

● Use S-VIDEO → "S-IN" (P. 27)

● Use DTV S-OUT → "S-OUT" (P. 27)

● Select dubbing sources

→ "DUBBING" (P. 27)

● Connect a decoder

→ "DECODER (EXT-2)" (P. 33)

EXT-3 Watching videos

Output ↑	Input ↓
	· Composite signal / S-VIDEO
	· Sound L / R

EXT-4 Watching DVDs

Output ↓	Input ↑
	· Component signal
	(P. 47)
	· Sound L / R

● Component auto select → (P. 33)

EXT-5 Connecting HDMI devices

Output ↑	Input ↓
	· HDMI signal
	(P. 47)

● HDMI setting → (P. 33)

AUDIO OUT

Listening to the TV on external speakers

Output ↓
· Sound L / R

IMPORTANT!

PREPARE

USE

SETTINGS

TROUBLE?

Initial settings

Register DTV/ATV channels on TV. These channels can be edited later.
 (In this manual, digital broadcasting is indicated as DTV, and analogue broadcasting as ATV.)

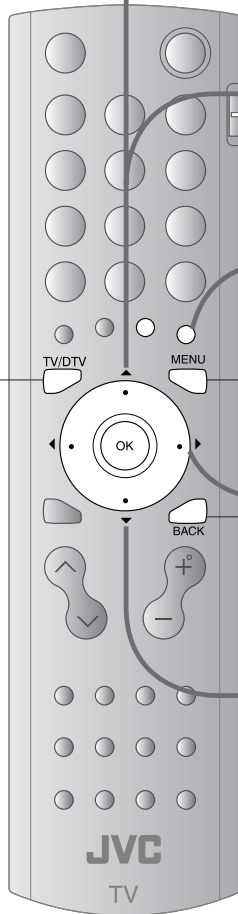
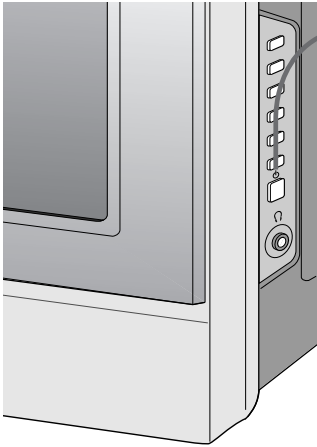

- To the previous screen → BACK
- Exit → TV/DTV
- If the "JVC" logo does not appear or if you wish to make changes later
 - DTV : "Automatic Search" (P. 38)
 - ATV : "AUTO PROGRAM"(P. 33)

What is "T-V LINK"?

Connecting the TV to a T-V LINK compatible device allows :

- ATV Channels on the TV to be instantly registered on the device.
- The "DIRECT REC" function to be used.
 - "Technical information" (P. 46)
- T-V LINK variations
 - "T-V LINK" (JVC) "Q-LINK" (Panasonic)
 - "Megalogic" (Grundig) "Data Logic" (Metz)
 - "SMARTLINK" (Sony) "Easy Link" (Philips)

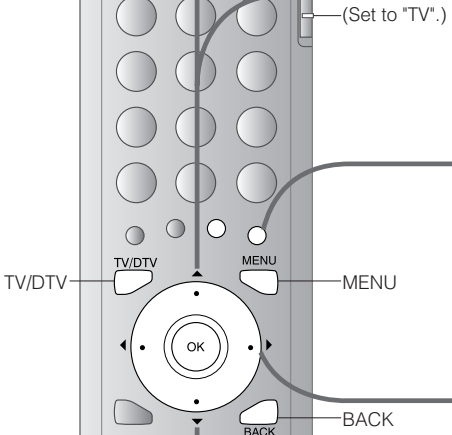

1

Begin



- Shown only when powering on for the first time.
- The power button on the remote control can also be used.

2

Automatically register DTV channels

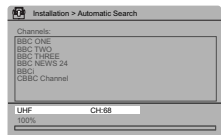
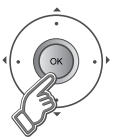

3

Check what was registered

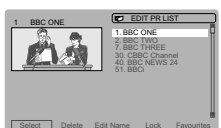

■ Edit DTV channels

➔ 5 in "Editing DTV channels" (P. 14)

■ Confirm MENU



4

Automatically register ATV channels

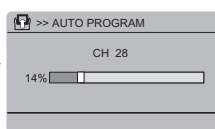
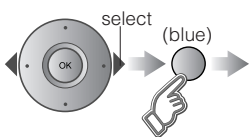

- If "ACI START" appears, select and start settings. (This will set up cable television channels.)
- ➔ "What is ACI (Automatic Channel Installation)?" (P. 46)

5

Check what was registered

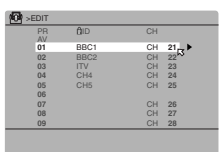

■ Edit ATV channels

➔ 5 in "Editing ATV channels" (P. 16)

■ Confirm



6

Finish

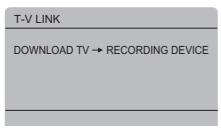

■ When using T-V LINK



- If "FEATURE NOT AVAILABLE" appears :
 - ➔ Is a T-V LINK compatible device connected to EXT-2?
 - ➔ Is the device turned on?

■ When not using T-V LINK TV/DTV



Editing DTV channels

Edit the channels registered with "Automatic search" in "Initial settings" (P. 12).

When coming from "Initial settings" (P. 12), skip to 5.

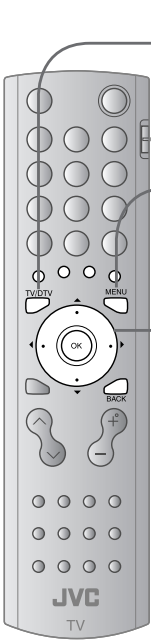

1

Select DTV
TV/DTV



2

Display the menu bar
MENU



3

Select "DTV"

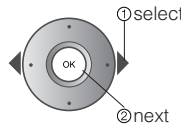
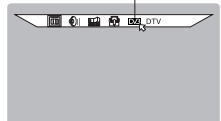

4

Select "Edit PR List"

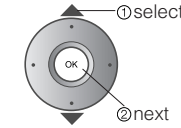
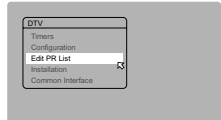

5

Select a channel

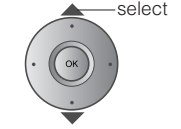
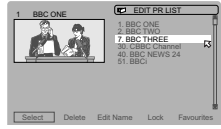

6

Edit

7

Finish
MENU



■ To the previous screen



■ Exit



■ Tips for operation



Confirm the channel picture

Select

Delete a channel

Delete

Edit a channel name

Edit Name

Stop Children from watching specific channels

Lock

Register your favourite channel

Favourites

①Select "Select"

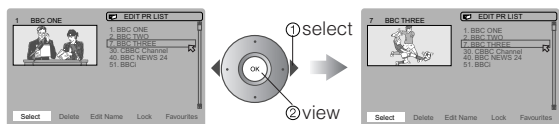

①Select "Delete"

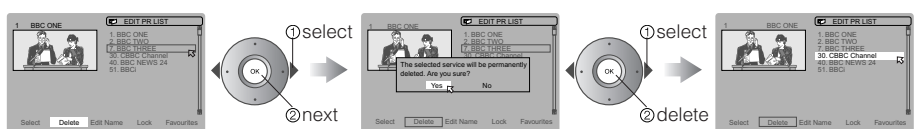

②Select "Yes"

①Select "Edit Name"

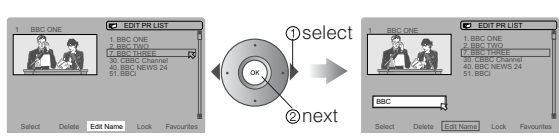

②Change the name

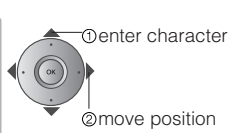

③Decide

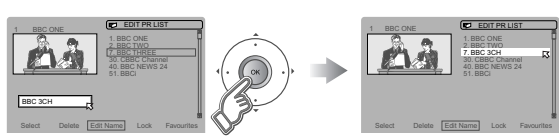

①Select "Lock"



②Enter PIN code

- Default is "0000".
- ➔ "Change the PIN code" (P. 37)
- To release, repeat the same steps.

①Select "Favourites"



- Move through only your favourite channels
- ➔ "Favourite Mode" (P. 37)
- To release, repeat the same steps.

Editing ATV channels

Edit the channels registered with "AUTO PROGRAM" in "Initial settings" (P. 12).

When coming from "Initial settings" (P. 12), skip to 5.

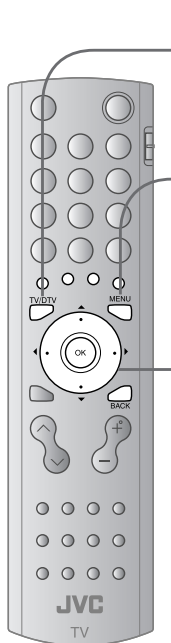

1

Select ATV
TV/DTV



2

Display the menu bar
MENU



3

Select "SET UP"

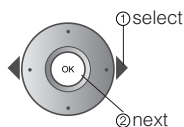
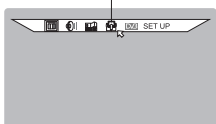

4

Select "EDIT/MANUAL"

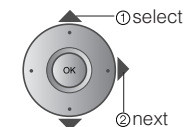
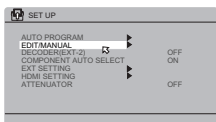

5

Select a row

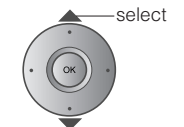
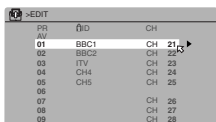

■ To the previous screen



■ Exit



6

Edit

7

Confirm settings

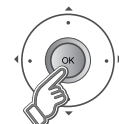

8

Finish



■ When using T-V LINK

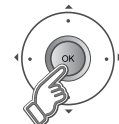

■ When not using T-V LINK



- If "FEATURE NOT AVAILABLE" appears :
 - ➔ Is a T-V LINK compatible device connected to EXT-2?
 - ➔ Is the device turned on?
- T-V LINK ➔ (P. 12)

Move a channel's position

MOVE

Edit a channel name

ID

Insert a channel

INSERT

Delete a channel

DELETE

Register a new channel

MANUAL

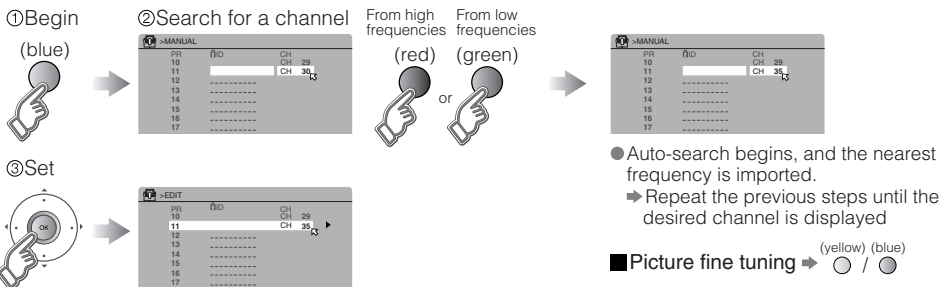
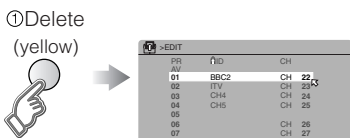
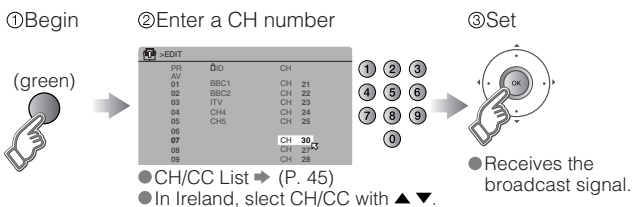
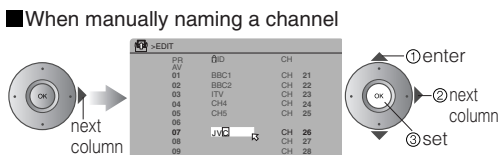
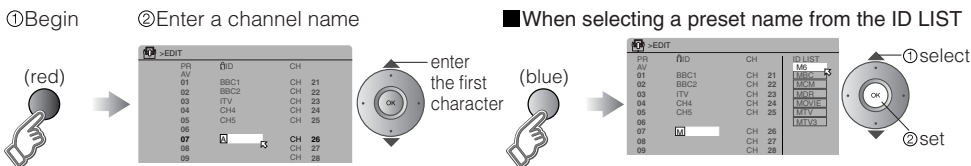
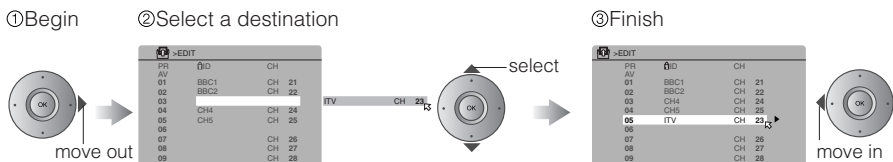

IMPORTANT!

PREPARE

USE

SETTINGS

TROUBLE?

Enjoying your new TV!

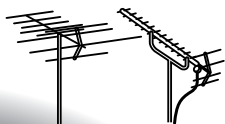

Watching TV

PAGE
20

- View channel information
- Change the aspect ratio
- Enjoy 3D sound
- Take snapshots of the screen



TV/DTV

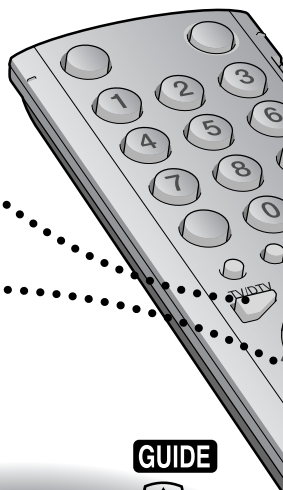
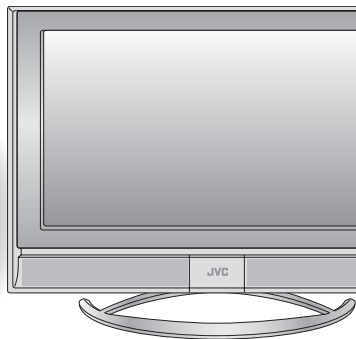

Viewing teletext

PAGE
24

- Enlarge the text
- To the index page
- Hold the current page
- Switch briefly between teletext and TV
- Bookmark your favourite pages

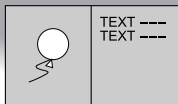

TV and Text mode

GUIDE



Using EPG

PAGE
22

- View the programme list for 8 days
- Search from a genre
- Reserve a programme to watch / record

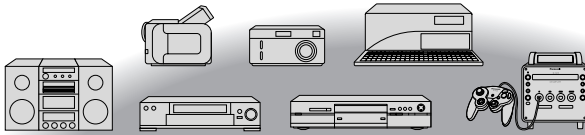

PAGE 26 Watching videos / DVDs



- Watch high quality video (S-VIDEO)
- Name connected devices
- Dub videos

MENU



PAGE 32 Personal preferences

■ Adjust the picture

■ Adjust the sound

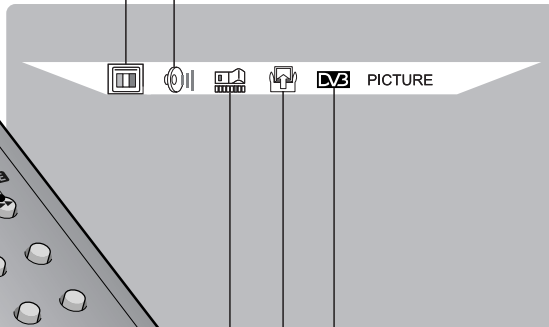

■ Use DTV

(timer-record / configuration / channel settings, etc.)

■ Basic settings

(channel settings, etc.)

■ Advanced settings

(sleep-timer / child lock, etc.)

IMPORTANT!

PREPARE

USE

SETTINGS

TROUBLE?

Watching TV

1 Power on

The green power lamp on the TV lights.

- Press again to turn the screen off and put the TV into standby mode.

2 Select ATV/DTV TV/DTV

- DTV : Digital broadcasting
- ATV : Analogue broadcasting

3 Select a channel

1 2 3
4 5 6
7 8 9
0

- Move up or down a channel
- up
- down
- With DTV, you can select only from your favourite channels ➔ (P. 37)
- To the previous channel
- BACK

■ Mute ■ Volume

■ Switch between stereo/mono/bilingual broadcasting
➔ "STEREO/I·II" (P. 32)

Note

- To completely turn off the TV, unplug the AC plug.
- Watch pay-per-view ➔ (P. 38)
- Add a new station ➔ (P. 38)

Basic operations using the side buttons

1 Power on

2 Change the channel

■ Volume

Channel information and clock

INFORMATION

View subtitles

SUBTITLE (DTV)

Change the aspect ratio

ZOOM

Enjoy ambient sound

3D SOUND

Take snapshots of the screen

FREEZE

■ When DTV is selected

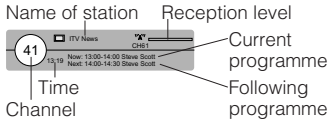

■ When ATV is selected

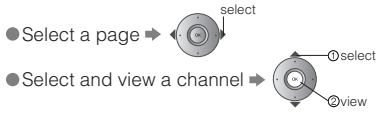
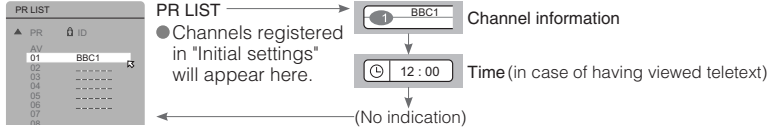

SUB TITLE



■ Turn off subtitles



ZOOM

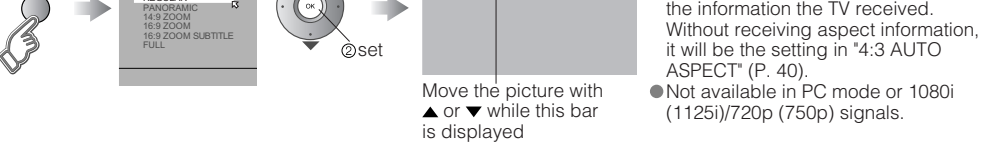

3D

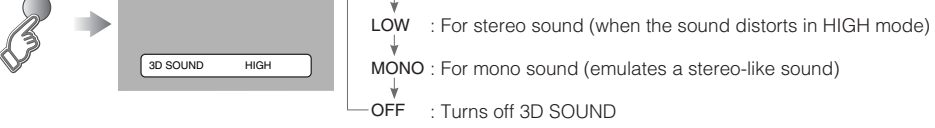

■ Cancel

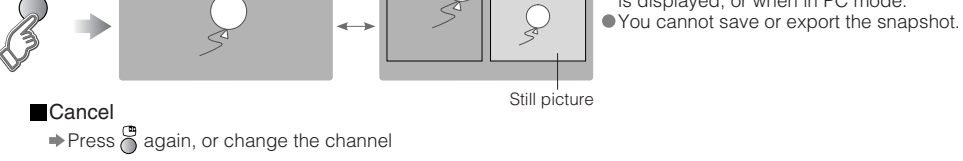

Using EPG (Electronic Programme Guide)

You can find a programme from an eight-day programme guide, check its information, and make a reservation.

1 Select DTV
TV/DTV

2 Display EPG
GUIDE

3 Find a programme
select next

Close EPG →

EPG
Electronic Programme Guide 05:27 20/10/2004

GENRE	All	
20/10	2. BBC TWO	04:00- History: Britain 1750-1900
21/10	7. BBC THREE	06:00- Big Cook Little Cook
22/10	30. CBBC Channel	06:20- Tots TV
23/10	40. BBC NEWS 24	06:30- Bobinogs
24/10	51. BBCi	06:45- Wide Eye
25/10	89. BBC R Scotland	07:00- Snailsbury Tales
26/10	90. BBC R n Gaidheal	07:15- Arthur
27/10	800. 16:9monoscope	07:30- I Love Mummy
04:00-6:00 History: Britain 1750-1900		
Secondary Schools, How industrialisation changed the day-to-day lives of the British people.		

Select a date → Select a channel → Select a programme

● You can check programme content.

■ Search from a genre

① While EPG is displayed...

Display the Genre List (green)



Electronic Programme Guide 05:27 20/10/2004

GENRE All

Genre

- All
- Little Cook
- News
- Sports
- Movies
- Tales
- Drama
- Entertainment
- mmy
- Lifestyle
- Kids
- Education

② Select a genre

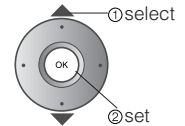

③ Find a programme

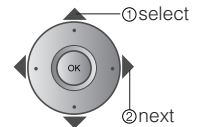

Electronic Programme Guide 05:43 20/10/2004

GENRE Movies

- 100:15- Last Embrace

● Only programmes in the selected genre are displayed.

Reservations

Reserve a programme to watch

Programme-view setting

After ③



Electronic Programme Guide		06:06	20/10/2004
2310	2 BBC TWO	06:00	Big Cooks Little Cooks
2310	1 BBC ONE	06:20	Toté TV
2310	40 BBC NEWS 24	06:45	Wide Eye
2410	51 BBC	07:00	Sainsbury Tales
2510	89 BBC R Scotland	07:15	Arthur
2610	10 BBC R i Galles	07:30	Llewellyn Mummy
2710	800 16 Monoscope	07:55	Newsworld



- At the start time, the channel will automatically change.
- If the TV's power is off at the start time, nothing happens.

■ Cancel the reservation → Select the reserved programme and press "OK"

After ③



REC TIMER		06:02	20/10/2004		
No.	Name	Start	End	Date	Mode
1	BBC ONE	00:00	00:00	01/01/2004	Inactive
2	BBC ONE	00:00	00:00	01/01/2004	Inactive
3	BBC ONE	00:00	00:00	01/01/2004	Inactive
4	BBC ONE	00:00	00:00	01/01/2004	Inactive
5	BBC ONE	00:00	00:00	01/01/2004	Inactive
6	BBC ONE	00:00	00:00	01/01/2004	Inactive
7	BBC ONE	Name	BBC TWO		
8	BBC ONE	Start	06:30		
9	BBC ONE	End	20/10/2004		
10	BBC ONE	Mode	Once		



REC TIMER		06:02	20/10/2004		
No.	Name	Start	End	Date	Mode
1	BBC TWO	06:30	06:45	20/10/2004	Active
2	BBC ONE	00:00	00:00	01/01/2004	Inactive
3	BBC ONE	00:00	00:00	01/01/2004	Inactive
4	BBC ONE	00:00	00:00	01/01/2004	Inactive
5	BBC ONE	00:00	00:00	01/01/2004	Inactive
6	BBC ONE	00:00	00:00	01/01/2004	Inactive
7	BBC ONE	00:00	00:00	01/01/2004	Inactive
8	BBC ONE	00:00	00:00	01/01/2004	Inactive
9	BBC ONE	00:00	00:00	01/01/2004	Inactive
10	BBC ONE	00:00	00:00	01/01/2004	Inactive

- Prepare for recording
 - Set the recording device to external input mode before the start time.
 - For T-V LINK incompatible devices, manually set the timer on the device.
 - For details, refer to the manual of the recorder.
 - Make sure that recording times on the recording device do not overlap with recording times on the TV.
 - When Rec Timer has been set, the power lamp on the TV will :
 - Start blinking 3 minutes before the start time (green or red)
 - Light during recording (green or orange)
 - Some T-V LINK compatible DVD recorders may not work correctly.

■ Exit → Press "MENU"

■ Confirm the reservation

GUIDE



Electronic Programme Guide		06:06	20/10/2004
2310	2 BBC TWO	06:00	Big Cooks Little Cooks
2310	30 BBC Channel	06:20	Toté TV
2310	40 BBC NEWS 24	06:45	Wide Eye
2410	51 BBC	07:00	Sainsbury Tales
2510	89 BBC R Scotland	07:15	Arthur
2610	10 BBC R i Galles	07:30	Llewellyn Mummy
2710	800 16 Monoscope	07:55	Newsworld



- At the start time, the channel will automatically change and the device connected to EXT-2 will begin recording the programme.

Reserve a programme to record

Programme-record setting

■ Change a reservation

→ "MENU" → "DV3" → "Rec Timer"

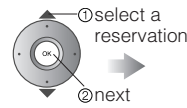

REC TIMER		06:02	20/10/2004		
No.	Name	Start	End	Date	Mode
1	BBC ONE	00:00	00:00	01/01/2004	Inactive
2	BBC ONE	00:00	00:00	01/01/2004	Inactive
3	BBC ONE	00:00	00:00	01/01/2004	Inactive
4	BBC ONE	00:00	00:00	01/01/2004	Inactive
5	BBC ONE	00:00	00:00	01/01/2004	Inactive
6	BBC ONE	00:00	00:00	01/01/2004	Inactive
7	BBC ONE	Name	BBC TWO		
8	BBC ONE	Start	06:30		
9	BBC ONE	End	06:45		
10	BBC ONE	Date	20/10/2004		
	BBC ONE	Mode	Once		

- Change with ◀▶
- Enter using the numerical keypad
- Change with ◀▶ (Once/Daily/Weekly)

■ Cancel a reservation

→ "MENU" → "DV3" → "Rec Timer"

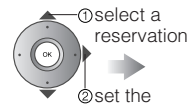

REC TIMER		06:02	20/10/2004		
No.	Name	Start	End	Date	Mode
1	BBC ONE	06:30	06:45	20/10/2004	Inactive
2	BBC ONE	00:00	00:00	01/01/2004	Inactive
3	BBC ONE	00:00	00:00	01/01/2004	Inactive
4	BBC ONE	00:00	00:00	01/01/2004	Inactive
5	BBC ONE	00:00	00:00	01/01/2004	Inactive
6	BBC ONE	00:00	00:00	01/01/2004	Inactive
7	BBC ONE	00:00	00:00	01/01/2004	Inactive
8	BBC ONE	00:00	00:00	01/01/2004	Inactive
9	BBC ONE	00:00	00:00	01/01/2004	Inactive
10	BBC ONE	00:00	00:00	01/01/2004	Inactive

IMPORTANT!

PREPARE

USE

SETTINGS

TROUBLE?

Viewing teletext

This TV can display TV broadcasts and teletext on the same channel in two windows.

1 Select ATV/DTV
TV/DTV

2

■ When DTV is selected
→ Operate according to the screen indications

■ When ATV is selected
→ Enter a teletext page

① ② ③
④ ⑤ ⑥
⑦ ⑧ ⑨
⑩

● Move up or down a page

up

P down

● View sub-pages

to sub-page

01 02

01 02

...

■ When ATV is selected
When watching TV

TV

TEXT

TEXT

TEXT

Bookmark your favourite page

LIST MODE
(ATV)

1 F.T/L Display your favourites list

(RED) (GREEN) (YELLOW) (BLUE)

???

2 Select a coloured button to save your page to

(red) (green) (yellow)(blue)

???

3 Enter the number of the page to save

① ② ③
④ ⑤ ⑥
⑦ ⑧ ⑨
⑩

???

4 Save

■ Recall your favourite page → Press the coloured button as in step 2

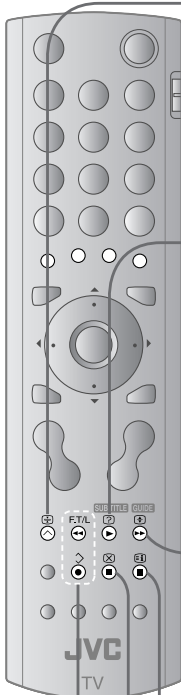

Hold the current page
 HOLD (ATV)

Hold the current page

■ Release → Press again

Reveal hidden pages
 REVEAL (ATV)

Display hidden information (answers to quizzes, etc)

$$\begin{array}{r} 1 + 2 = \\ 2 \times 3 = \end{array} \longleftrightarrow \begin{array}{r} 1 + 2 = 3 \\ 2 \times 3 = 6 \end{array}$$

Enlarge the text
 SIZE (ATV)

Double the size of the displayed text

To the index page
 INDEX (ATV)

Returns to page "100" or a previously designated page

Switch briefly from teletext to TV
 CANCEL (ATV)

Leave the current page open, while you switch to watch TV

● Useful when running a page search.

IMPORTANT!

PREPARE

USE

SETTINGS

TROUBLE?

Watching videos / DVDs

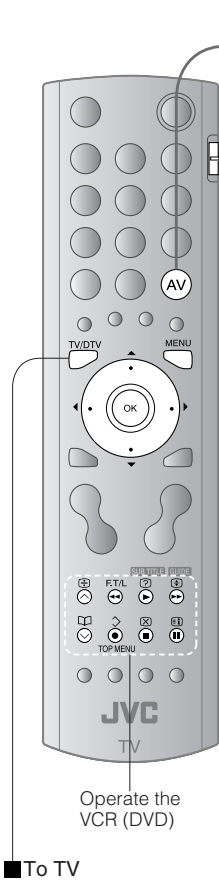

1 Select the video source

AV → [E1 VCR]

E.g. For EXT-1

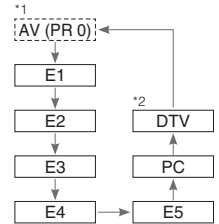

2 Operate the connected device and play a video

*1 : Only appears when AV has been registered as a channel.
 *2 : Switches to DTV.

Operate JVC VCRs and other devices

1 DVD players
 VCRs and DVD recorders

2 Turn on the device

3 Select a channel (VCR mode)

[F.T/L] [?] [↶] [↷] — Rewind/Playback/Fast-forward

[TOP MENU] [X] [E1] — Stop/Pause

Record/Display DVD top menu

Select a chapter (DVD mode)

● Some models of JVC devices cannot be operated with this remote control.

Advanced functions



1 **MENU** Display the menu bar

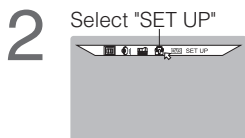

Select "EXT SETTING"

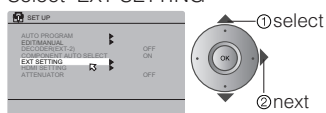

Switch to S-VIDEO input/output

S-IN

S-OUT
(DTV)

① Select the EXT connected to S-VIDEO

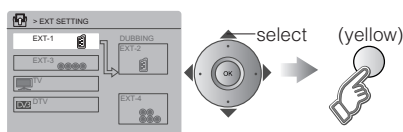

② Set S-VIDEO input

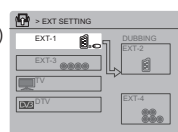

■ Cancel this mode → Press **(yellow)** in ② again

■ Set the S-OUT → Cancel S-IN at "EXT-2", then select "DTV" and press yellow button. (available only for DTV)

- The device selection display will change from E1 to S1.
- S-OUT is not available when EXT-2 receives an RGB input.

Edit names of connected devices

ID LIST

① Select an EXT to assign a name to

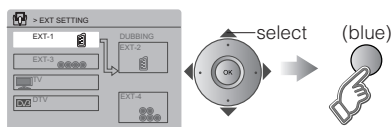

② Show the name list

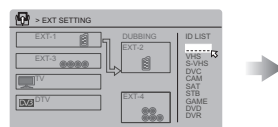

③ Select a name from the list

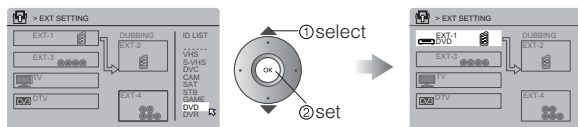

■ Clear the name → Select the blank space in ③

Set up dubbing on EXT-2

DUBBING

① Select the arrow

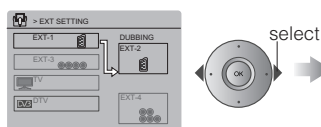

② Select the dubbing source

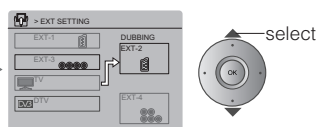

■ Record DTV with S-VIDEO → Set S-OUT at "DTV".

IMPORTANT!

PREPARE

USE

SETTINGS

TROUBLE?

Useful functions

Watch in multi-picture mode

MULTI-PICTURE

Select the number of screens

Selecting " 1 " returns to normal viewing mode
 ● Not available in PC mode.

■ Watch in dual-picture mode

E.g. You can watch TV and video at the same time.

(For 1080i, 720p signal)

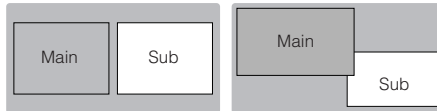

● Switch between the sound sources



● Change the channel

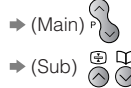

■ Select a channel in 12-screen mode (ATV)

All registered channels are displayed as still images.

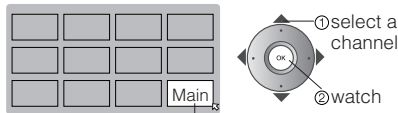

Only the selected frame has a moving picture.

● Move up or down a page



● Not available when in DTV channels or EXT-5 input.

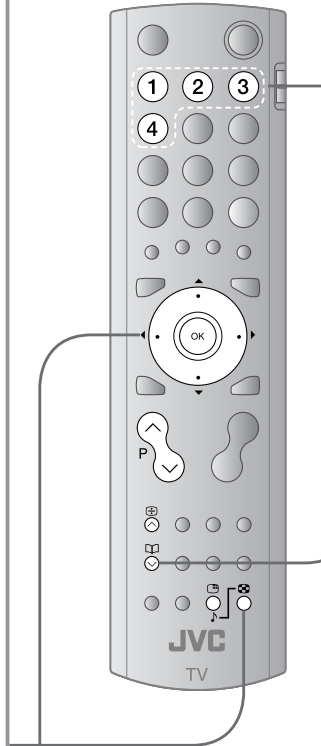

Register a channel to a button FAVOURITE CHANNEL (ATV)

While the channel is displayed (For 3 seconds)

Press the number to register it on

1 2 3 4

SET 1 - 4?

PROGRAMMED!

- "NOT AVAILABLE" is displayed: Already registered
- Disappears after a few seconds

Recall the favourite channel

Press the number you registered

1 2 3 4

FAVOURITE 1 - 4?

BBC1

- Customisations (P. 32) to the picture of a favourite channel get saved as well.
- "NOT MEMORY" is displayed: Not registered

Check your favourite channels → Press and confirm that the channels you have registered have a beside them

Delete a favourite channel

→ "MENU" → → "FEATURES" → "FAVOURITE SETTING"

FAVOURITE SETTING

	PR 07
	PR 01
	PR 23
	PR 11

select

Delete (blue)

FAVOURITE SETTING

	PR 07
	PR 01
	PR 11

Useful functions

Set a time for the TV to turn itself off

SLEEP TIMER

- 

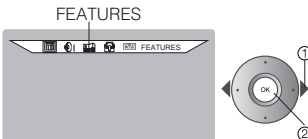
MENU
- 

FEATURES

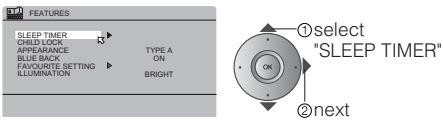
① select "FEATURES"
② next
- 

FEATURES

SLEEP TIMER
CHILD LOCK
APPEARANCE
BLUE BACK
FAVOURITE SETTING
ILLUMINATION

TYPE A
ON
BRIGHT

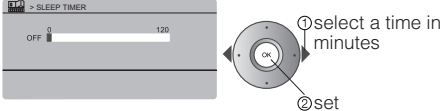
① select "SLEEP TIMER"
② next
- 

SLEEP TIMER

OFF 0 120

① select a time in minutes
② set

■ Cancel

- ➔ Set the time to "0" in step 4

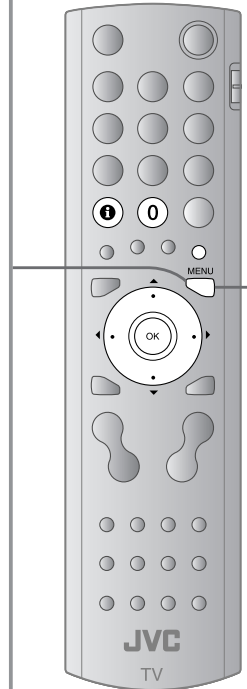

■ Remaining time

- ➔ You can confirm the remaining time at step 4, after repeating this process.



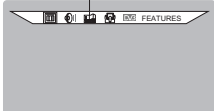
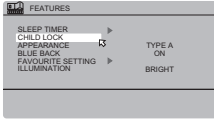
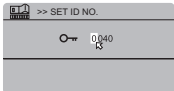
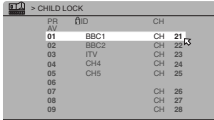

Stop children from watching specific channels

CHILD LOCK (ATV)

- 1 
- 2 
 - ① select "FEATURES"
 - ② next
- 3 
 - select "CHILD LOCK"
- 4 
 - ① enter an "ID NO." (a secret number of your choice)
 - ② to the next column
 - ③ set
- 5 
 - select a channel to lock
- 6 (blue) 
 - Lock more channels
 - Repeat steps 5 and 6
- 7 

■ Release a channel ➔ Press  again in step 6

■ View a locked channel ➔ Use the numerical buttons to enter the channel number. When  appears, press  and enter your "ID NO." (If you forget your "ID NO.", check it in step 4.)

Customising your TV

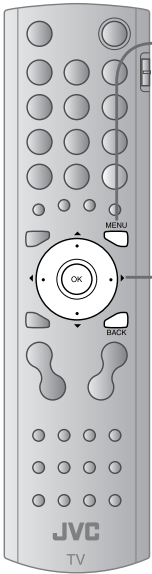

1 Display the menu bar

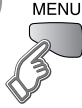

2 Select a menu

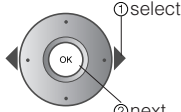

3 Select an item

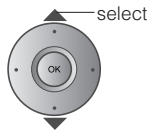

4 Adjust/Configure

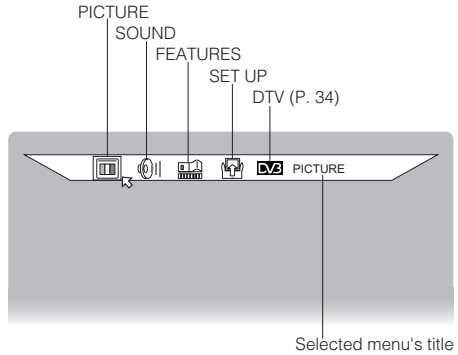
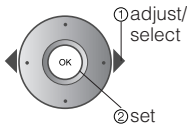

Selected menu's title

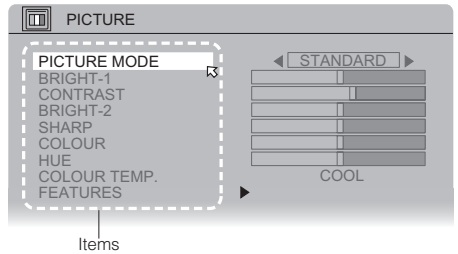

Items

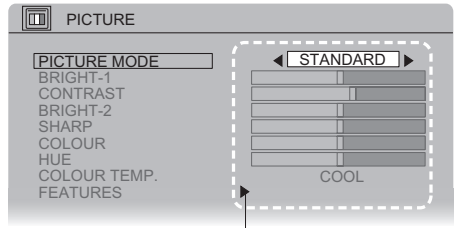

Sub-menu Adjustments / Configurations

■ To the previous screen



■ Exit



● The menu disappears after one minute of inactivity.

■ When adjusting with the sliding-bar

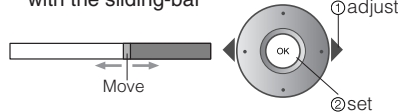



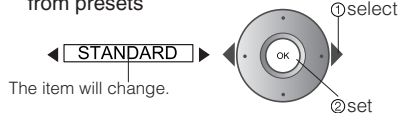

■ When selecting from presets



The item will change.

● Some items have a sub-menu.

Menu	Item	Adjustments / Configurations
 PICTURE	PICTURE MODE	Picture mode (BRIGHT / STANDARD / SOFT)
	BRIGHT-1	Backlight brightness (Darker ⇔ Brighter)
	CONTRAST	Contrast (LOWER ⇔ HIGHER)
	BRIGHT-2	Brightness (DARKER ⇔ BRIGHTER)
	SHARP	Sharpness (SOFTER ⇔ SHARPER)
	COLOUR	Colour (LIGHTER ⇔ DEEPER)
	HUE	Tint (REDDISH ⇔ GREENISH)
	COLOUR TEMP.	Colour temperature (WARM / NORMAL / COOL)
	FEATURES	Finer picture adjustments (P. 40)
 SOUND	STEREO / I · II	Mode / Language (∞ : STEREO / ○ : MONO / I : SUB1 / II : SUB2)
	BASS	Low tones (WEAKER ⇔ STRONGER)
	TREBLE	High tones (WEAKER ⇔ STRONGER)
	BALANCE	Speaker balance (LEFT STRONGER ⇔ RIGHT STRONGER)
	3D SOUND	Ambience level (HIGH / LOW / MONO / OFF)
	A.H.B.	Emphasize the bass sound (ON / OFF)
	BBE *	Sound enhancement technology (ON / OFF)
	SPEAKER	Output (TV SOUND / Sound from CENTRE CH input)
 FEATURES	SLEEP TIMER	Timer for turning off the TV (P. 30)
	CHILD LOCK	Stop children from watching specific channels (P. 31)
	APPEARANCE	Format for displaying the channel number (TYPE A / TYPE B / TYPE C / TYPE D)
	BLUE BACK	Display a blue screen and mute the sound when the signal is weak or absent (ON / OFF)
	FAVOURITE SETTING	Clear favourite channel settings (P. 29)
	ILLUMINATION	Lights illumination lamp (P.6) while the power is turned on (BRIGHT / SOFT / OFF)
 SET UP	AUTO PROGRAM	Select the country of installation, automatically register channels (P. 12, 4)
	EDIT / MANUAL	Change registered channels or add new ones (P. 16)
	DECODER(EXT-2)	For when connected to VCR with T-V LINK (ON / OFF)
	COMPONENT AUTO SELECT	Changes the TV input to EXT-4 when the component signals are input to EXT-4. (ON/OFF) (Not available when viewing DTV or PC)
	EXT SETTING	For use with video players and other devices (P. 27)
	HDMI SETTING	SIZE (AUTO / 1 / 2) AUDIO (AUTO / ANALOGUE / DIGITAL)
	ATTENUATOR	For when the picture is not displayed because of too strong radio waves (ON/OFF)

● Other settings · Change the aspect ratio ➔ "ZOOM" (P. 20)
· Turn on 3D SOUND ➔ "3D SOUND" (P. 20)

* BBE licence ➔ (P. 46)

IMPORTANT!

PREPARE

USE

SETTINGS

TROUBLE?

Using DTV

Timer-record setting

DTV original function and setting, such as a recorder-linked timer-record setting, can be selected from the DTV menu.



- 1** Select DTV
TV/DTV
- 2** Display the menu bar
MENU
- 3** Select "DTV"
- 4** Select an item

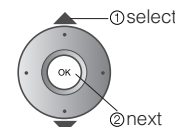
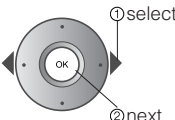
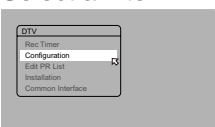
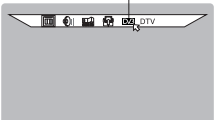

■ To the previous screen



■ Exit



● The menu disappears after one minute of inactivity.

● DTV menu cannot be operated with the front panel buttons.

- Rec Timer ➔ "Recording using timer setting" (P. 34)
- Configuration ➔ "Change AV settings" (P. 36)
- Edit PR List ➔ "Editing DTV channels" (P. 14)
- Installation ➔ "Reset channel/Register a new channel/Initialise the DTV settings" (P. 38)
- Common Interface ➔ "Set pay-per-view" (P. 38)

Recording using timer setting

Rec Timer

1 Select an "Inactive" column

No.	Name	Start	End	Date	Mode
1	BBC ONE	00:00	00:00	01/01/2000	Inactive
2	BBC ONE	00:00	00:00	01/01/2000	Inactive
3	BBC ONE	00:00	00:00	01/01/2000	Inactive
4	BBC ONE	00:00	00:00	01/01/2000	Inactive
5	BBC ONE	00:00	00:00	01/01/2000	Inactive

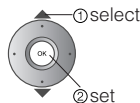

● Settings can be overwritten.

Channels Start to End Dates Timer-record setting state (Active : timer set
Inactive : completed, cancelled)

2 Input timer-record setting details

No.	Name	Start	End	Date	Mode
1	BBC ONE	00:00	00:00	01/01/2004	Inactive
2	BBC ONE	00:00	00:00	01/01/2004	Inactive
3	BBC ONE	00:00	00:00	01/01/2004	Inactive
4	BBC ONE	00:00	00:00	01/01/2004	Inactive
5	BBC ONE	00:00	00:00	01/01/2004	Inactive
6	BBC ONE	00:00	00:00	01/01/2004	Inactive
7	BBC ONE	00:00	00:00	01/01/2004	Inactive
8	BBC ONE	00:00	00:00	01/01/2004	Inactive
9	BBC ONE	00:00	00:00	01/01/2004	Inactive
10	BBC ONE	00:00	00:00	01/01/2004	Inactive

Name	BBC TWO
Start	06:30
End	06:45
Date	20/10/2004
Mode	Once

Change with ◀▶
Enter using the numerical keypad
Change with ◀▶ (Once/Daily/Weekly)

3 Set



No.	Name	Start	End	Date	Mode
1	BBC TWO	06:30	06:45	20/10/2004	Active
2	BBC ONE	00:00	00:00	01/01/2000	Inactive
3	BBC ONE	00:00	00:00	01/01/2000	Inactive
4	BBC ONE	00:00	00:00	01/01/2000	Inactive
5	BBC ONE	00:00	00:00	01/01/2000	Inactive
6	BBC ONE	00:00	00:00	01/01/2004	Inactive
7	BBC ONE	00:00	00:00	01/01/2004	Inactive
8	BBC ONE	00:00	00:00	01/01/2004	Inactive
9	BBC ONE	00:00	00:00	01/01/2004	Inactive
10	BBC ONE	00:00	00:00	01/01/2004	Inactive

- A message will be displayed if you set past dates.
- The channel will be selected automatically at the set start time, and the recorder connected to EXT-2 will start recording.

● For more details about the timer-record setting, refer to the notice of
➔ "Prepare for recording" (P. 23)

■ Cancel a timer-record setting

- ➔ Select the column at step 1 and press ▶. (Mode will be changed to "Inactive")

■ Change a timer-record setting

- ➔ Select the column at step 1 and repeat steps 2 and 3.

Using DTV

AV setting

Available for changing subtitle languages for DTV, favourite channel selection, changing PIN code, and upgrading the tuner software. Also, you can upgrade the tuner software as newer versions become available.

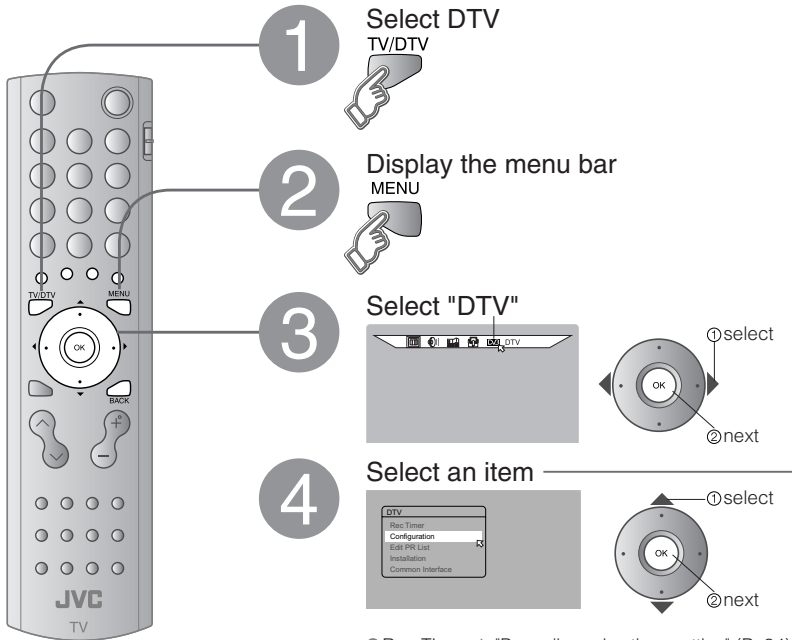

■ To the previous screen



■ Exit



- The menu disappears after one minute of inactivity.

- DTV menu cannot be operated with the front panel buttons.

- Rec Timer → "Recording using timer setting" (P. 34)
- Configuration → "Change AV settings" (P. 36)
- Edit PR List → "Editing DTV channels" (P. 14)
- Installation → "Reset channel/Register a new channel/Initialise the DTV settings" (P. 38)
- Common Interface → "Set pay-per-view" (P. 38)

Change AV settings

Configuration

1 Select a configuration item

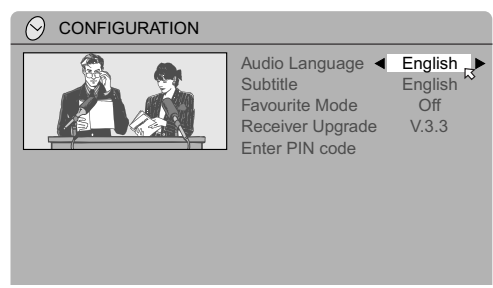

2 Change settings

- **Audio Language** / **Subtitle** : Change language
- **Favourite Mode** : Channel selection method

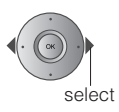

Audio Language	Switch languages (English / Welsh / Gaelic)
Subtitle	
Favourite Mode	Select only DTV channels registered by using "Favourites"(P. 14) with ^ / v (On/Off)

- **Receiver Upgrade** : Upgrade tuner



Automatic Download	Automatically and periodically (Enabled/Disabled)
Search for New Version	Download now (Press "OK" button.)

- **Enter PIN code** : Change PIN code



① Input the current code

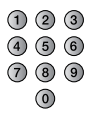
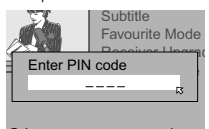

- Default is "0000".
- If you forget the code → Default the code in "Reset channel registration" (P. 38)

② Input a new code twice.

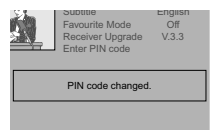
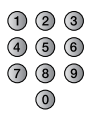
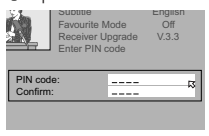

Using DTV

Registration and setting

Available for registration of DTV channels, initialisation of all DTV settings, and downloading software to use pay-per-view.

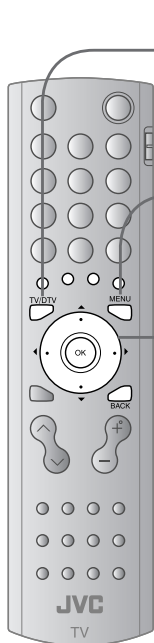

1 Select DTV
TV/DTV

2 Display the menu bar
MENU

3 Select "DTV"

4 Select an item

■ To the previous screen
→ BACK

■ Exit
→ MENU

● The menu disappears after one minute of inactivity.

● DTV menu cannot be operated with the front panel buttons.

- Rec Timer ⇒ "Recording using timer setting" (P. 34)
- Configuration ⇒ "Change AV settings" (P. 36)
- Edit PR List ⇒ "Editing DTV channels" (P. 14)
- Installation ⇒ "Reset channel/Register a new channel/Initialise the DTV settings" (P. 38)
- Common Interface ⇒ "Set pay-per-view" (P. 38)

Reset channel registration

Register a new channel

Initialise the DTV settings

Installation

Set pay-per-view

Common Interface

1 Select an installation item

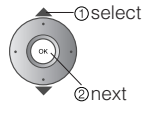
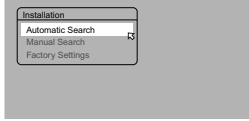

2 Change setting

Automatic Search : Reset channel registration

① Select "Yes"

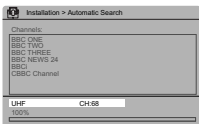
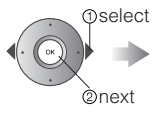
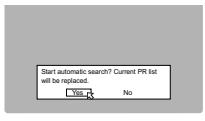

● Displays "Edit PR List" (P. 14) after registering channels.

Manual Search : Register a new channel

① Enter a channel number

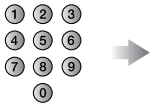
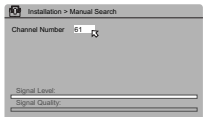

② Receive the channel

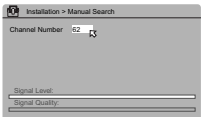

● When receiving is completed, a message will be displayed and the screen will return to ①.

Factory Setting : Initialise the DTV settings

① Select "Yes"

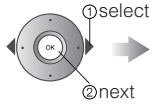
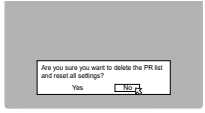

② Start channel registration

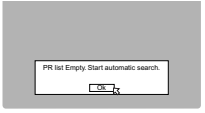

➡ ③ in "Initial settings" (P.12)

Preparation : Set the CAM etc. after contracting with the broadcasting company
 ➡ "Watch pay-per-view" (P. 8)

① Select the broadcasting station

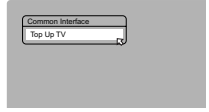

② Select "Software Download"

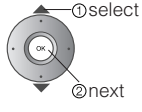
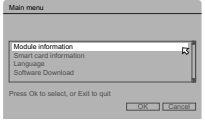

③ Select "Yes"

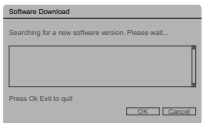
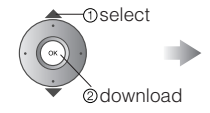
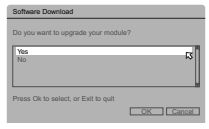

● Use this menu for settings and contract content for pay-per-view.
 ➡ For details, consult your broadcasting company

Advanced picture adjustment

By default, the TV automatically adjusts itself for the best picture.

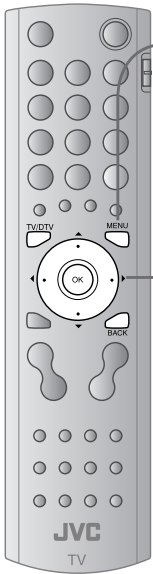

1 Display the menu bar

MENU

2 Select "PICTURE"

3 Select "FEATURES"

4 Select an item

E.g. DIGITAL VNR

5 Change settings

E.g. DIGITAL VNR

6 Finish

■ To the previous screen



■ Exit



● The menu disappears after one minute of inactivity.

DIGITAL VNR

Super DigiPure

MOVIE THEATRE

COLOUR MANAGEMENT

PICTURE MANAGEMENT

COLOUR SYSTEM

4:3 AUTO ASPECT

To reduce noise

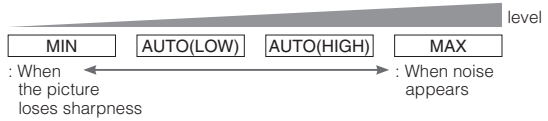
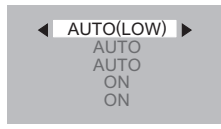

For natural-looking outlines

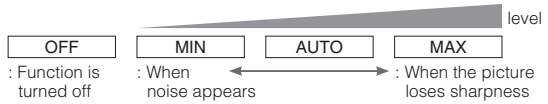
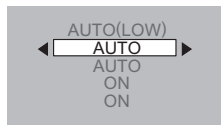

For smooth cinema film

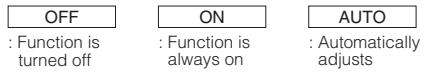
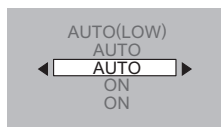

For natural-looking pictures

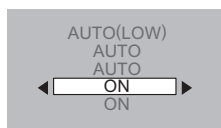

Fix bright/dark pictures

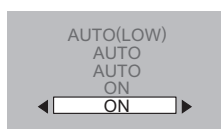

When there is no colour

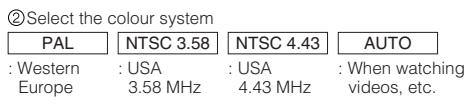
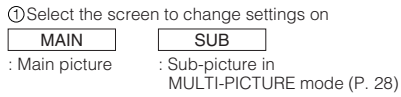
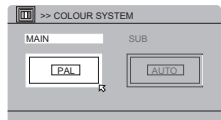

Set a default aspect ratio

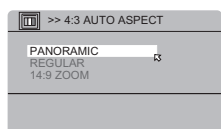

Select a default aspect ratio for "AUTO" in "ZOOM" (P.20)

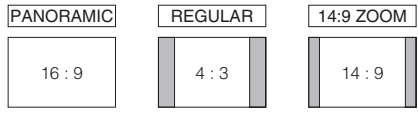

Troubleshooting

Severe noise or snow



- Is the TV connected correctly to the aerial?
- Change the direction of the aerial.
- Is the aerial or its cable damaged?
 - ➔ Consult your retailer

Patterns, stripes or noise



- Is the aerial receiving interference from high-voltage power lines or wireless transmitters?
 - ➔ Consult your retailer
- Are connected devices too close to the TV?
 - ➔ Insert the minimum distance between the aerial and the cause of interference until no interference

Ghosting

(Doubling of images)



- Are you receiving interference from signals reflected off mountains or buildings?
 - ➔ Adjust the direction of your aerial, or change to a good-quality directional aerial

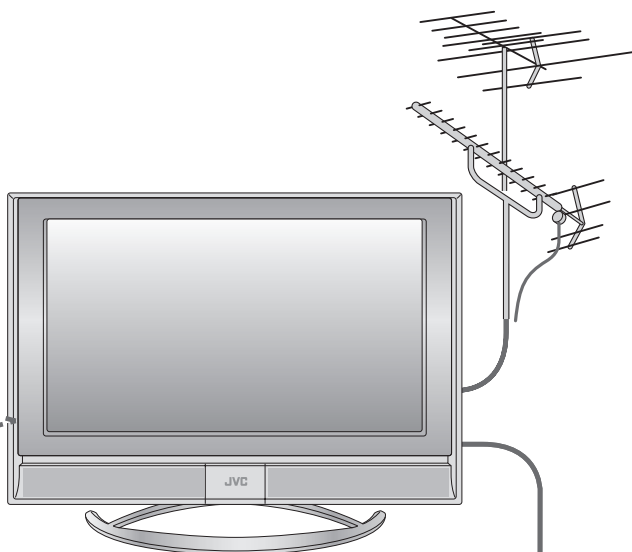

I can't turn it on!

- Is the power cord connected to the AC outlet correctly?

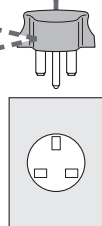

The remote control doesn't work!

- Are the batteries flat?
- Are you more than 7 metres away from the TV?
- Is the "VCR/TV/DVD SWITCH" set to "TV"?
- When viewing teletext, the TV menu bar does not appear.
- Depending on the stability of the signal, there may be a time lag when changing channels.

Problem		Actions	page
Basics	Not displayed (black screen)	<ul style="list-style-type: none"> ● Is the ATV reception poor, too? ➔ Following the instructions in "Severe noise or snow" can solve this problem. ● Is there a DTV transmission tower nearby? ➔ Turn "ATTENUATOR" to "ON", since the radio waves are too strong. ● There may be problems at the antenna, radio waves, or the area you live in, where reception is bad. Consult your retailer. 	42 33 —
	Remote control stops working	<ul style="list-style-type: none"> ● Unplug TV, several minutes later plug it in again. 	—
	DTV screen is frozen	<ul style="list-style-type: none"> ● Hold down TV/AV and MENU/OK on the TV simultaneously to restart. 	—
	Some functions do not work	<ul style="list-style-type: none"> ● It is not a malfunction. Some functions (dark background) in the menu do not work depending on the situation. 	—
Screen	Aspect ratio changes unintentionally	<ul style="list-style-type: none"> ● Press ZOOM to return to your settings. 	20
	Poor picture quality	<ul style="list-style-type: none"> ● Unnatural colour >>> Adjust COLOUR and BRIGHT-1. Check your COLOUR SYSTEM. ● Noise >>> Set to the following functions. PICTURE MODE : STANDARD DIGITAL VNR : AUTO (HIGH) Super DigiPure : MIN ● Dull picture >>> Set to the following functions. PICTURE MODE : BRIGHT DIGITAL VNR : MIN Super DigiPure : MAX 	33 40 33 40 40 32 40 40
Picture	Strange picture when using an external device	<ul style="list-style-type: none"> ● If you connected S-Video output device, check the "S-IN" setting. ● If the top of the image is distorted, check the video signal quality itself. ● If movement appears unnatural when receiving a signal from a DVD player, etc. with 625p (progressive-scanning), change the output setting of the external device to 625i (interlace-scanning). 	27 — —
	Poor sound	<ul style="list-style-type: none"> ● Adjust the BASS and TREBLE. ● If receiving a poor signal in "STEREO/I·II", switch to MONO. 	33 33
Sound			

Troubleshooting (continued)

	Problem	Actions	page
HDMI	Wrong screen size	● Switch SIZE in HDMI SETTING to "1" or "2".	33
	No sound	● Switch AUDIO in HDMI SETTING to ANALOGUE or DIGITAL.	33
	Green and distorted screen	● Wait a little for the signal to stabilize when switching the signal format for an HDMI device.	—
Functions	Some inputs are skipped in the sub-picture	● DTV channels, EXT-4/EXT-5 inputs, and PC mode cannot be selected in the sub-picture.	—
Error message	"FEATURE NOT AVAILABLE"	<ul style="list-style-type: none"> ● Is the T-V LINK compatible device connected to EXT-2? ● Is the SCART CABLE "Fully Wired"? ● Is the T-V LINK compatible device turned on? After confirming all the conditions above, press "OK" button again.	46 46 —
	"ACI ERROR"	● Press ◀ to start ACI again. If you still receive the "ACI ERROR" after numerous tries, press ▶ to cancel ACI.	—
	"NO RECORDING"	● A problem occurs at the recorder.	—
	"NO RECORDING POSSIBLE"	● The displayed video cannot be recorded.	—
	"NO RECORDING MEDIA PROBLEM"	● The recorder is not ready for recording. Check the videotape or DVD disc.	—
	"NO RECORDING DEVICE BUSY"	● The recorder is recording another programme, or is playing.	—
Screen	Black or white dots appear on the screen	<ul style="list-style-type: none"> ● LCD panels use fine dots ("pixels") to display images. While more than 99.99% of these pixels function properly, a very small number of pixels may not light, or may light all the time. Please understand that this is not a malfunction. 	—

An error message does not disappear

- Deleting a DTV channel may cause an error message to appear while other channels displayed.
 - ➔ Register channels again in "Automatic Search"

CH/CC List

- To use the INSERT function (P. 16), find the CH/CC number corresponding to the TV's channel number from this table. If you want to know a particular TV channel's channel menu, look in TV listings magazines or contact the broadcaster.
- When the COUNTRY setting is UNITED KINGDOM, the CC number channels and channels from CH02 to CH12 cannot be received.

CH	Channel
CH 02	E2, IR A
CH 03	E3, IR B
CH 04	E4, IR C
CH 05	E5, IR D
CH 06	E6, IR E
CH 07	E7, IR F
CH 08	E8, IR G
CH 09	E9
CH 10	E10, IR H
CH 11	E11, IR J
CH 12	E12
CH 21	E21
CH 22	E22
CH 23	E23
CH 24	E24
CH 25	E25
CH 26	E26
CH 27	E27
CH 28	E28
CH 29	E29
CH 30	E30
CH 31	E31
CH 32	E32
CH 33	E33
CH 34	E34
CH 35	E35
CH 36	E36
CH 37	E37
CH 38	E38
CH 39	E39

CH	Channel
CH 40	E40
CH 41	E41
CH 42	E42
CH 43	E43
CH 44	E44
CH 45	E45
CH 46	E46
CH 47	E47
CH 48	E48
CH 49	E49
CH 50	E50
CH 51	E51
CH 52	E52
CH 53	E53
CH 54	E54
CH 55	E55
CH 56	E56
CH 57	E57
CH 58	E58
CH 59	E59
CH 60	E60
CH 61	E61
CH 62	E62
CH 63	E63
CH 64	E64
CH 65	E65
CH 66	E66
CH 67	E67
CH 68	E68
CH 69	E69

CC	Channel
CC 01	S1
CC 02	S2
CC 03	S3
CC 04	S4
CC 05	S5
CC 06	S6
CC 07	S7
CC 08	S8
CC 09	S9
CC 10	S10
CC 11	S11
CC 12	S12
CC 13	S13
CC 14	S14
CC 15	S15
CC 16	S16
CC 17	S17
CC 18	S18
CC 19	S19
CC 20	S20
CC 21	S21
CC 22	S22
CC 23	S23
CC 24	S24
CC 25	S25
CC 26	S26
CC 27	S27
CC 28	S28
CC 29	S29
CC 30	S30

CC	Channel
CC 31	S31
CC 32	S32
CC 33	S33
CC 34	S34
CC 35	S35
CC 36	S36
CC 37	S37
CC 38	S36
CC 39	S39
CC 40	S40
CC 41	S41
CC 75	X
CC 76	Y
CC 77	Z
CC 78	Z+1
CC 79	Z+2

Technical information

What is T-V LINK?

T-V LINK allows the TV to share information easily with a connected T-V LINK compatible device. By using T-V LINK :

- You can send the ATV channel information programmed on the TV to the T-V LINK compatible device, so that both the TV and the external device have the same channel settings. When connecting a new external device, channel information is loaded into it, allowing channel setup to be completed very quickly. For more details, refer to the external device's manual.
- You can easily record the TV programme you are viewing on a T-V LINK compatible device by using the "DIRECT REC" feature. For more details, refer to the external device's manual.
- After timer-record setting, the TV will instruct the recorder to start and stop recording, via DIRECT REC.

What is ACI (Automatic Channel Installation)?

Some cable companies transmit a signal called ACI which contains information that allows TV channels to be registered automatically on your TV.

When an ACI signal is received, "ACI START/ACI CANCEL" appears in the "AUTO PROGRAM" screen.

PC Signals that can be displayed

Macintosh computers are not supported.
(Macintosh is a registered trademark of Apple Computer, Inc.)

- If the signal doesn't appear, check that the vertical frequency on the PC is set to 60Hz.

Resolution	640 x 480 (VGA)	1024 x 768 (XGA)
Vertical frequency (Hz)	60.0	60.0
Horizontal frequency (kHz)	31.5	42.0

Connect DVI devices

Connect a DVI device to EXT-5 (HDMI) using DVI-HDMI conversion cable. Connect analogue sound output of the DVI device to L and R terminals in EXT-4.

- Set AUDIO in HDMI SETTING to ANALOGUE or AUTO ➔ (P. 33)

If you accidentally cut the power cord

Attach a new plug following the steps below. If in doubt, contact your local retailer.

Important

- Never connect to the larger terminal marked with an "E", the safety earth symbol "⏏" or coloured green or green-and-yellow.
- The wires in the mains lead on this product are coloured with the following code:
 - Blue: Neutral wire (connect to the black terminal, or one marked "N")
 - Brown: Live wire (connect to the red terminal, or one marked "L")

Change the fuse in the plug

Open the plug as illustrated on the right.

- When replacing the fuse, always use a correctly rated and approved type and re-fit the fuse cover when finished.

If in doubt, contact your local retailer.

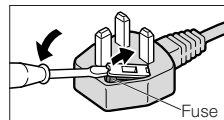

Licence

Manufactured under license from BBE Sound, Inc.

Licensed by BBE Sound, Inc. under USP4638258, 5510752 and 5736897.

BBE and BBE symbol are registered trademarks of BBE Sound, Inc.

Specifications

Main unit

Model	LT-32DS6BJ/SJ	LT-26DS6BJ/SJ
Broadcasting systems	CCIR, I	
Colour systems	PAL ·The EXT terminals also support the NTSC 3.58/4.43 MHz system.	
Channels and frequencies	<ul style="list-style-type: none"> ● Analogue : E21-E69 (UNITED KINGDOM) IR A-J, E2-E12, E21-E69 (IRELAND) ● Digital : 474 MHz-850MHz (channel 21-68) 	
Sound-multiplex systems	NICAM (I) system.	
Teletext systems	Analogue : FLOF (Fastext), WST (World Standard System). Digital : MHEG 5 UK profile	
Power requirements	AC 110 V - 240 V, 50/60Hz	
Audio output (Rated power output)	10 W + 10 W	
Speakers	6.6 cm round x 2	
Power consumption	152 W (standby : 2.6 W)	131 W (standby : 2.6 W)
Screen size (visible area size measured diagonally)	80 cm	66 cm
Dimensions (W x H x D : mm)	808 x 611 x 225 808 x 558.5 x 108 (without stand)	703 x 536.8 x 225 703 x 483 x 107 (without stand)
Weights	21.0 kg 17.2 kg (without stand)	18.0 kg 14.0 kg (without stand)
Accessories	(See "Check accessories", P. 5)	

- This TV has the CAM (Conditional Access Module) slot for watching pay-per-view.
Please note that the CAM and viewing card must be purchased separately.

Terminals / Connectors

Terminal name		Terminal type	Signal type (IN)	Signal type (OUT)
Input / Output terminals	EXT-1	Euroconnector x1 (SCART connector)	Composite video, S-video, Analog RGB, AUDIO L / R	TV out
	EXT-2	Euroconnector x1 (SCART connector)	Composite video, S-video, Analog RGB, AUDIO L / R	Dubbing out (S-VIDEO out is available only for DTV channels)
Input terminals	EXT-3	RCA connectors x 3, S-VIDEO connector x 1	Composite video, S-video AUDIO L / R	
	EXT-4	RCA connectors x 5	Analogue component (576i (625i) / 480i (525i), Progressive : 576p (625p) / 480p (525p), HD : 1080i (1125i), 720p (750p)) AUDIO L / R	
	EXT-5 (HDMI)	HDMI connector x 1	HDMI (576i (625i) / 480i (525i) / 576p (625p) / 480p (525p), 1080i (1125i), 720p (750p))	
	PC INPUT	D-SUB (15 pins) x 1	Analogue PC signal (P. 46)	
Output terminals	AUDIO OUT	RCA connectors x 2		Audio L / R
	Headphone	Stereo mini-jack x 1 (3.5 mm in diameter)		Headphone output

- We may change the design and specifications without notice.

IMPORTANT!

PREPARE

USE

SETTINGS

TROUBLE?

JVC

For users in the UK :

If you have any problems setting up your new TV, please call the **JVC** Helpline on **0870 330 5000**.

For users in the Republic of Ireland :

If you have any problems setting up your new TV, please call the **JVC** Helpline on **1890-582500**.